

Migel

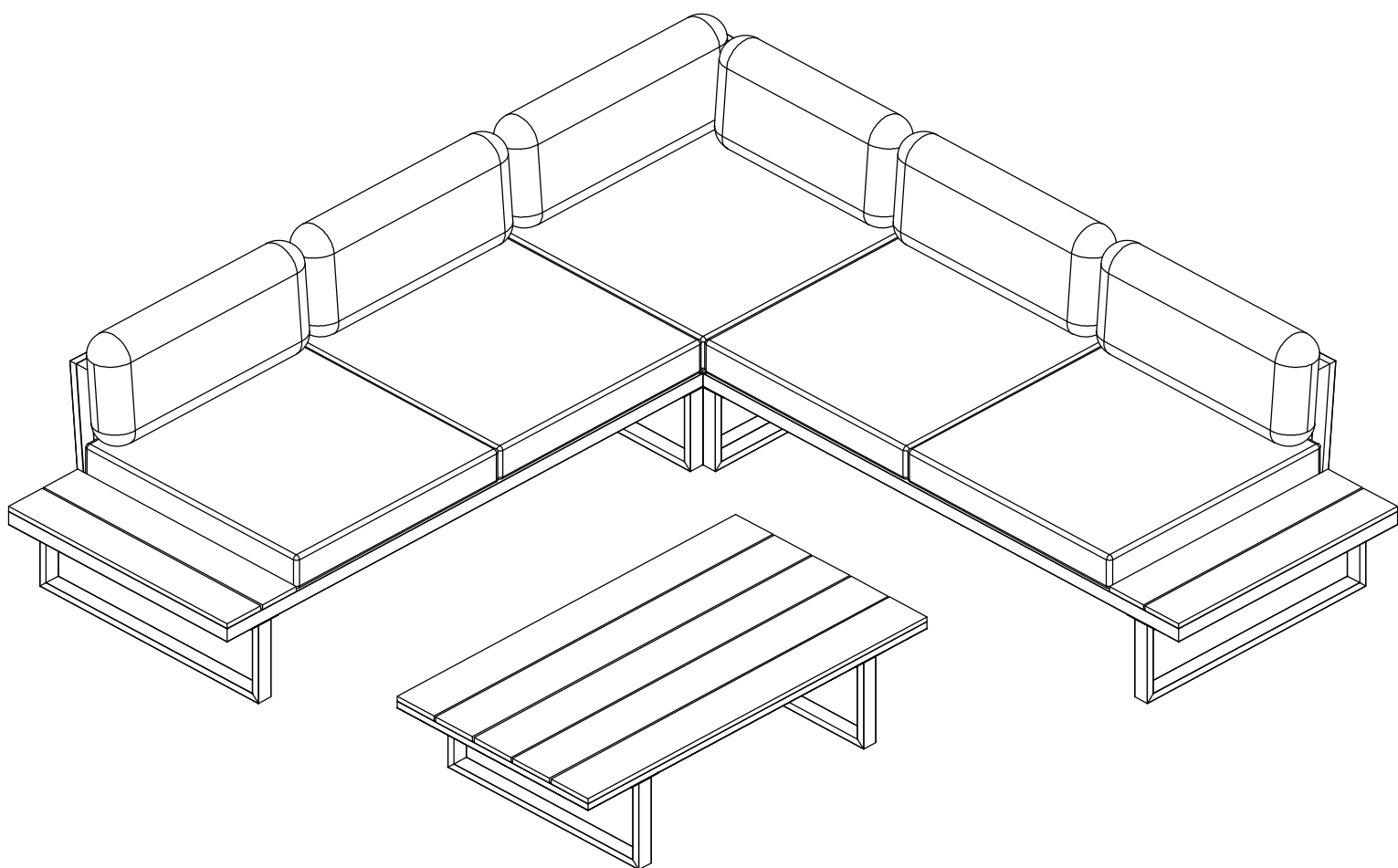

RAVENNA No 1

GR: ΣΗΜΑΝΤΙΚΕΣ ΠΛΗΡΟΦΟΡΙΕΣ!

Διαβάστε προσεκτικά ολόκληρο το εγχειρίδιο πριν από την συναρμολόγηση ή/και την χρήση του προϊόντος. Ακολουθήστε προσεκτικά τις οδηγίες του εγχειριδίου και κρατήστε τις για μελλοντική αναφορά.

GB: IMPORTANT INFORMATION!

Please read the entire manual carefully before starting to assemble and/or using this product. Follow the manual thoroughly and keep it for further reference.

SE: VIKTIG INFORMATION!

Läs bruksanvisningen i sin helhet innan du börjar att montera och/eller använda produkten. Följ bruksanvisningen noggrant och spara den för framtida referens.

NO: VIKTIG INFORMASJON!

Les hele bruksanvisningen nøye før du begynner å montere og/eller bruke dette produktet. Følg bruksanvisningen nøye, og ta vare på den for fremtidig bruk.

FI: TÄRKEITÄ TIETOJA

Lue käyttöohjeet kokonaan ennen tämän tuotteen kokoamista ja/tai käyttöä. Noudata käyttöohjeita tarkasti ja säilytä ne myöhempää tarvetta varten.

PL: WAŻNE INFORMACJE.

Przed użyciem produktu należy dokładnie zapoznać się ze wskazówkami bezpieczeństwa. Należy zapoznać się z instrukcją obsługi i zachować ją do użytku w przyszłości.

CZ: DŮLEŽITÉ INFORMACE!

Před sestavením nebo použitím výrobku si pečlivě přečtěte celý návod. Dodržujte důsledně uvedené pokyny a návod uschovejte, aby byl k dispozici v případě potřeby.

HU: FONTOS INFORMÁCIÓ

A termék összeszerelésének vagy használatának megkezdése előtt figyelmesen olvassa el a teljes útmutatót. Őrizze meg az útmutatót, és gondosan tartsa be a benne foglaltakat.

SK: DÔLEŽITÉ INFORMÁCIE!

Predtým ako začnete s montážou a/alebo používaním tohto produktu si pozorne prečítajte celý návod. Návod dôsledne dodržiavajte a ponechajte si ho pre použitie v budúcnosti.

NL: BELANGRIJKE INFORMATIE!

Lees de volledige handleiding zorgvuldig door voordat u dit product monteert en/of gebruikt. Volg de handleiding zorgvuldig en bewaar deze voor toekomstig gebruik.

SI: POMEMBNE INFORMACIJE!

Pred montažo/uporabo izdelka pozorno preberite ta navodila za uporabo. Upoštevajte navodila in jih shranite, saj jih boste morda še potrebovali.

RU: ВАЖНАЯ ИНФОРМАЦИЯ!

Внимательно и полностью прочитайте это руководство, прежде чем приступить к сборке или использованию этого изделия. Следуйте всем инструкциям этого руководства и сохраните его на будущее для справки.

HR: VAŽNE OBAVIJESTI!

Molimo Vas pažljivo pročitajte upute za uporabu prije sastavljanja i/ili korištenja ovog proizvoda. Strogo se pridržavajte uputa i sačuvajte ih za buduće potrebe.

BA: VAŽNE INFORMACIJE!

Prije sklapanja i/ili korištenja ovog proizvoda, pažljivo pročitajte cijeli priručnik. Pažljivo se pridržavajte uputstava u priručniku i sačuvajte ga za buduću upotrebu.

CN: 重要信息!

组装和/或使用本产品之前请通读该手册。请严格遵循手册说明, 保留手册供日后参考。

RS: VAŽNE INFORMACIJE!

Pažljivo pročitajte kompletan priručnik pre nego što počnete da sklapate i/ili koristite ovaj proizvod. Detaljno sledite priručnik i sačuvajte ga za kasniju upotrebu.

UA: ВАЖЛИВА ІНФОРМАЦІЯ.

Уважно прочитайте весь посібник, перш ніж збирати та/чи використовувати цей продукт. Виконайте всі інструкції цього посібника та збережіть його для подальшого використання.

RO: INFORMAȚII IMPORTANTE

Citiți cu atenție întregul manual înainte de a începe să montați și/sau să utilizați acest produs. Urmați îndeaproape instrucțiunile din manual și păstrați-l pentru consultare ulterioară.

BG: ВАЖНА ИНФОРМАЦИЯ!

Моля, прочетете цялото ръководство внимателно, преди да започнете да сглобявате и/или използвате този продукт. Следвайте стриктно ръководството и го пазете за бъдещи справки.

DK: VIGTIG INFORMATION!











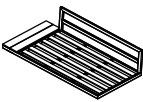

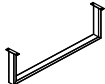
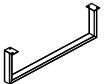
Læs hele manualen grundigt igennem før samling og/eller brug af dette produkt. Følg manualen nøje, og opbevar den til senere brug.

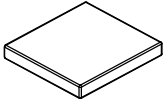



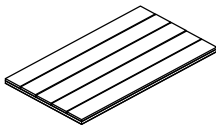

TR: ÖNEMLİ BİLGİLER!

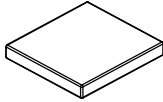
Bu ürünün montajını yapmaya başlamadan ve/veya ürünü kullanmadan önce lütfen kılavuzun tamamını dikkatlice okuyun. Kılavuzu adım adım izleyin ve daha sonra başvurmak üzere saklayın.

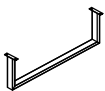
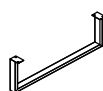
FR: INFORMATIONS IMPORTANTES

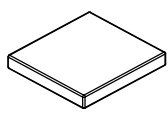
Veillez lire attentivement l'ensemble du manuel avant de commencer à monter et/ou utiliser ce produit. Suivez rigoureusement le manuel et conservez-le pour toute consultation ultérieure.

A		1	B		1	C		1
D		2	E		4	F		2
G		4	H		5	I		1
J		2	K		1	L	 M6x15	40
M		40	N		1	Q		1

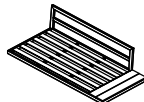



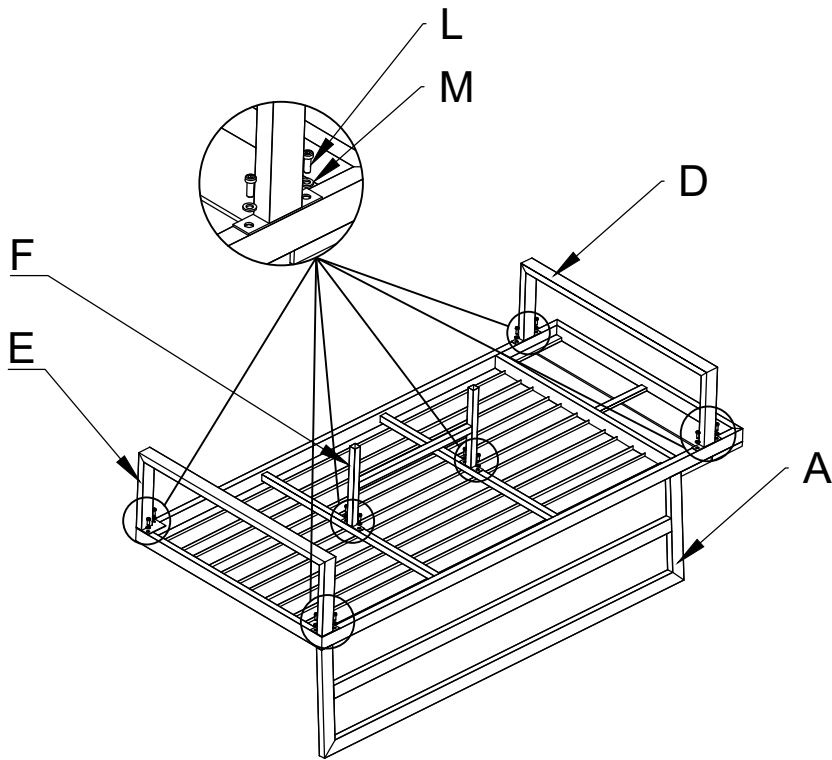

D		1	E		1	F		1
G		2	H		2	L	 M6x15	12
M		12	N		1	A		1

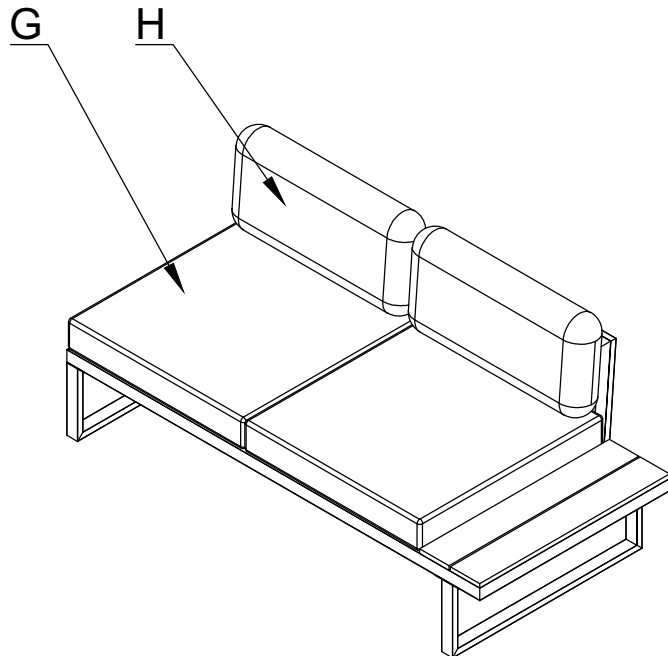
1

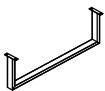
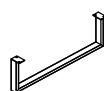

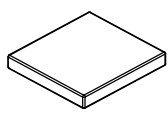
2



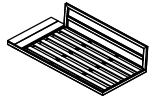



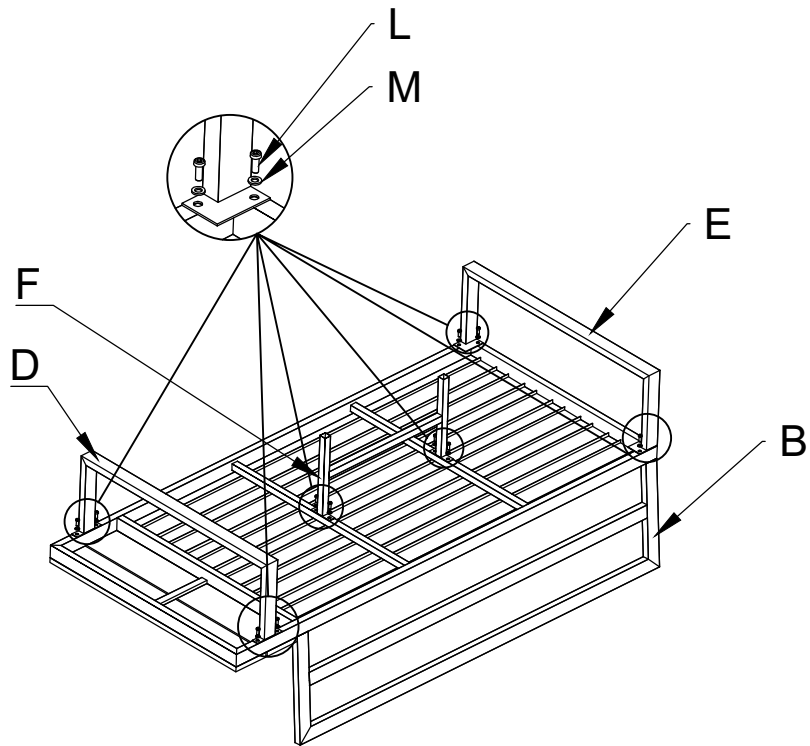

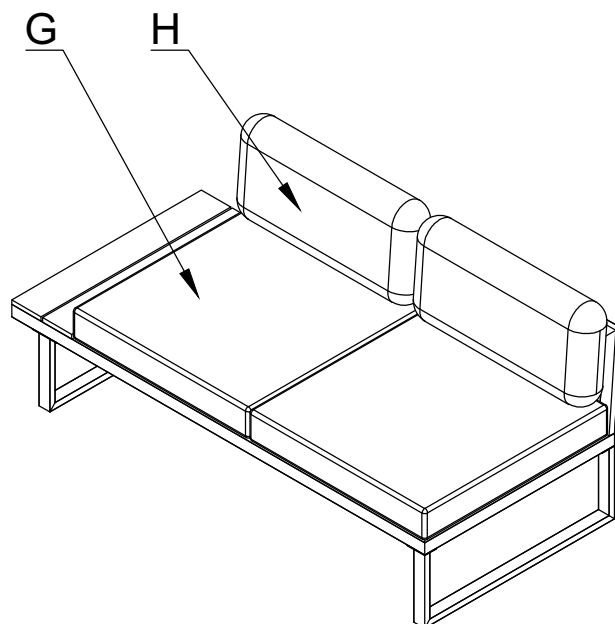

D		1	E		1	F		1
G		2	H		2	L	 M6x15	12
M		12	N		1	B		1

1

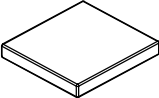

2







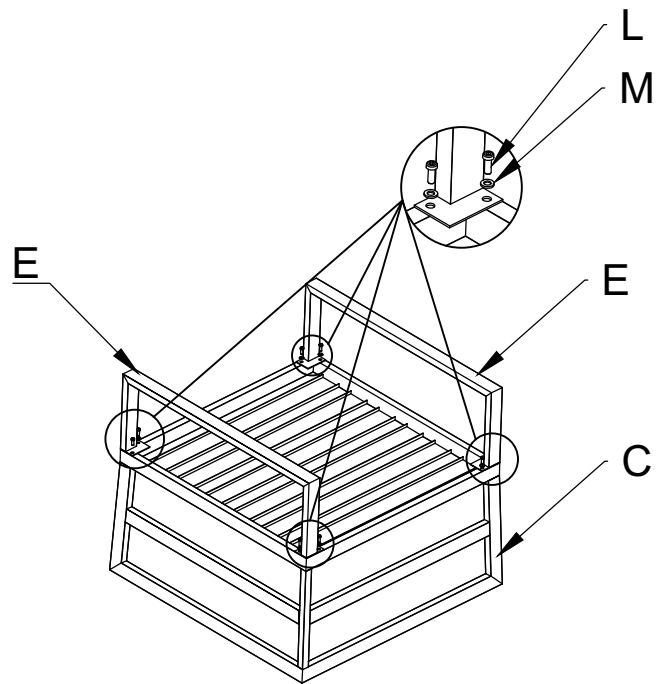

C		1	E		2	I		1
Q		1	H		1	L	 M6x15	8
M		8	N		1			

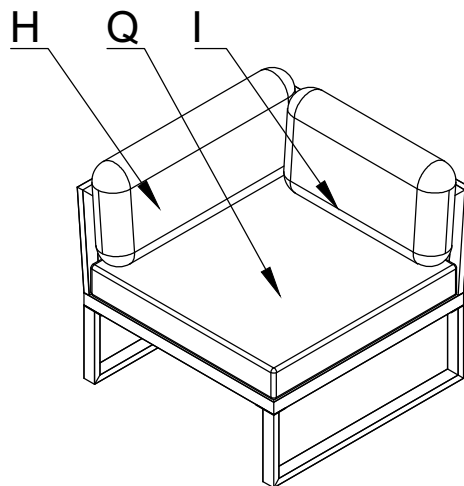
1

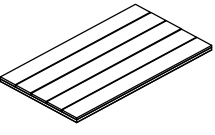

2



J		2	K		1	L	 M6x15	8
M		8	N		1			

1

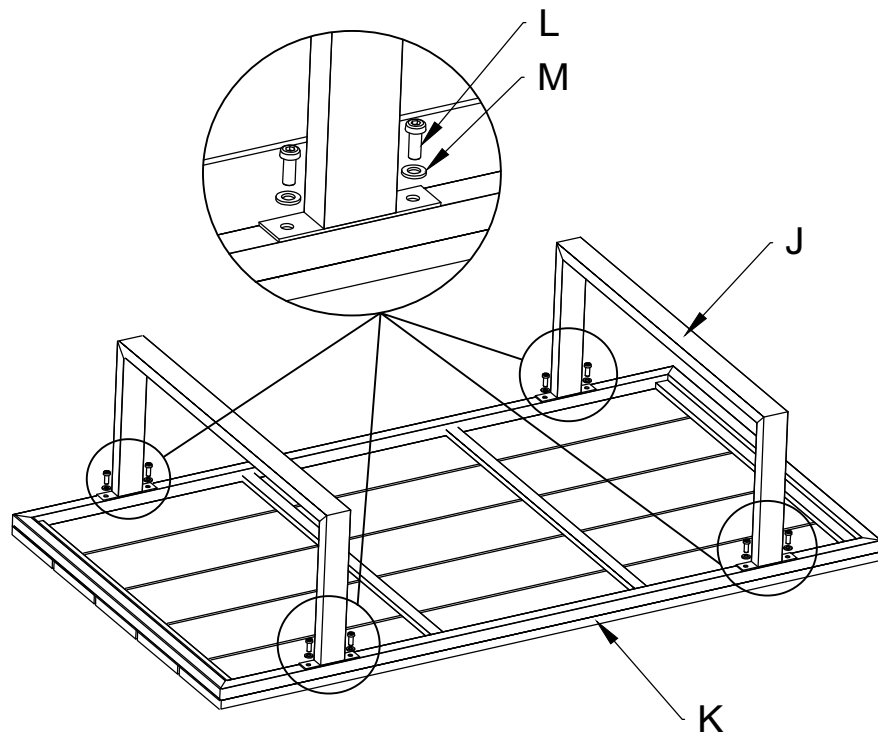

2

