

# RAVENNA No1

# LARNACA

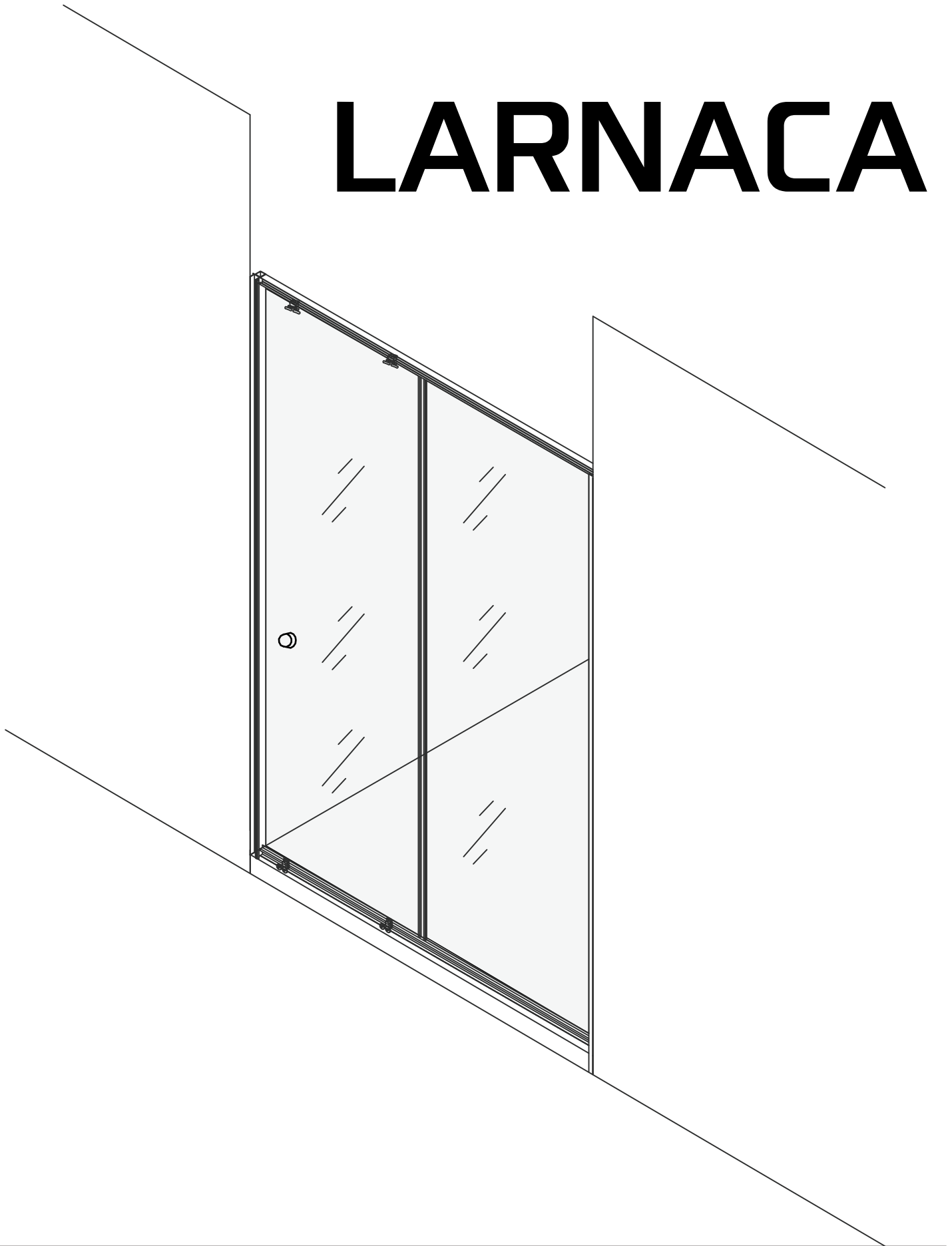

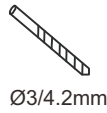

Ø3/4.2mm

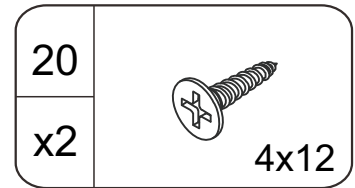
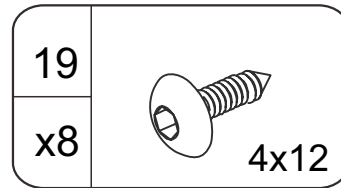
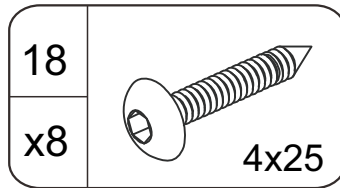
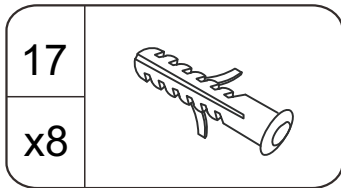
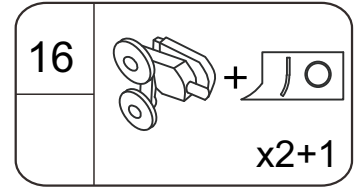
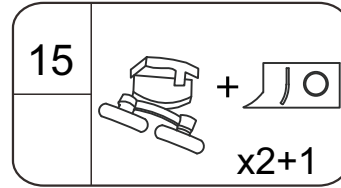
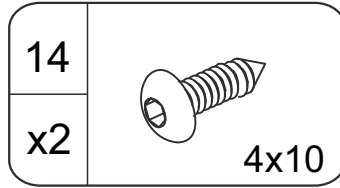
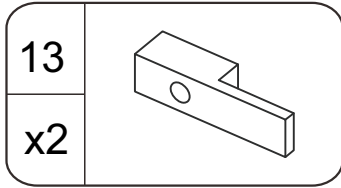
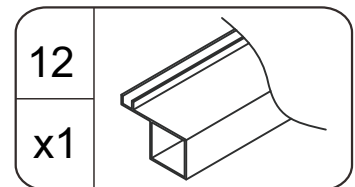
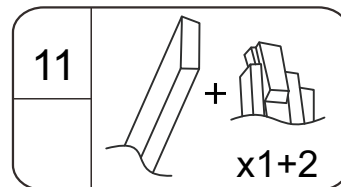
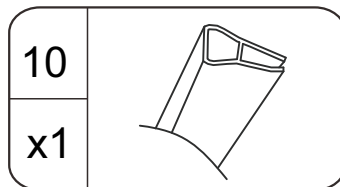
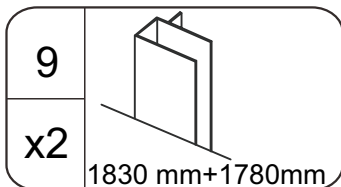
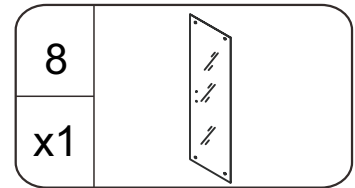
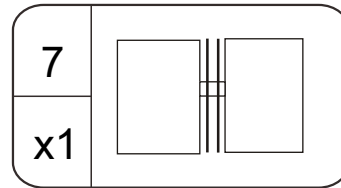
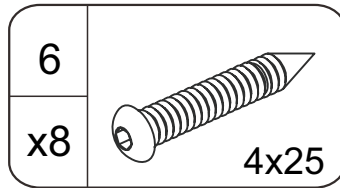
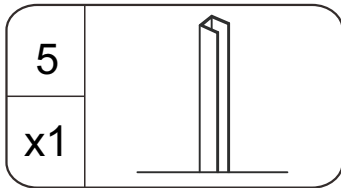
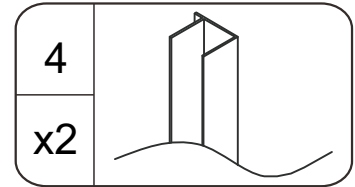
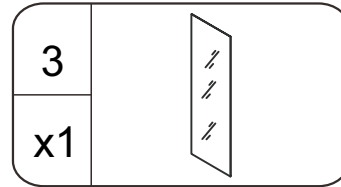
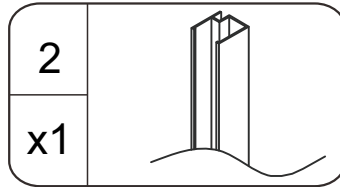
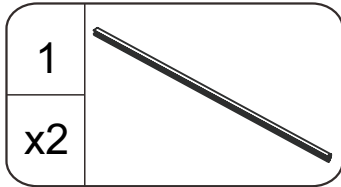
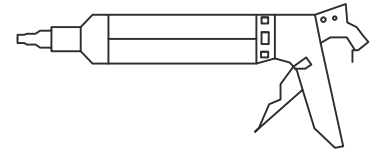
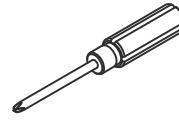
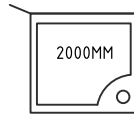
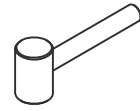
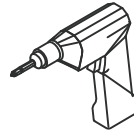

Πριν ξεκινήσετε παρακαλώ διαβάστε τα παρακάτω:

Προσέξτε όταν μετακινείτε τα τζάμια.

Προσέξτε να μην χτυπηθούν οι άκρες ή οι γωνίες.

Το αλουμίνιο είναι ένα μαλακό μέταλλο και υφίσταται μία σειρά από επεξεργασίες μέχρι να έρθει στην τελική του μορφή.

Μερικά σημάδια στην επιφάνεια του είναι φυσιολογικά λόγω της επεξεργασίας.

Ο ποιοτικός μας έλεγχος διασφαλίζει ότι το προϊόν είναι άρτιο για την τοποθέτησή του.

Προσοχή κατά την τοποθέτηση βεβαιωθείτε ότι τα σημεία που τρυπάτε δεν έχουν σωλήνες ή καλώδια.

**ΣΗΜΕΙΩΣΗ:** Οι εικόνες μπορεί να διαφέρουν από την πραγματικότητα αλλά σε κάθε περίπτωση η τοποθέτηση είναι ίδια.

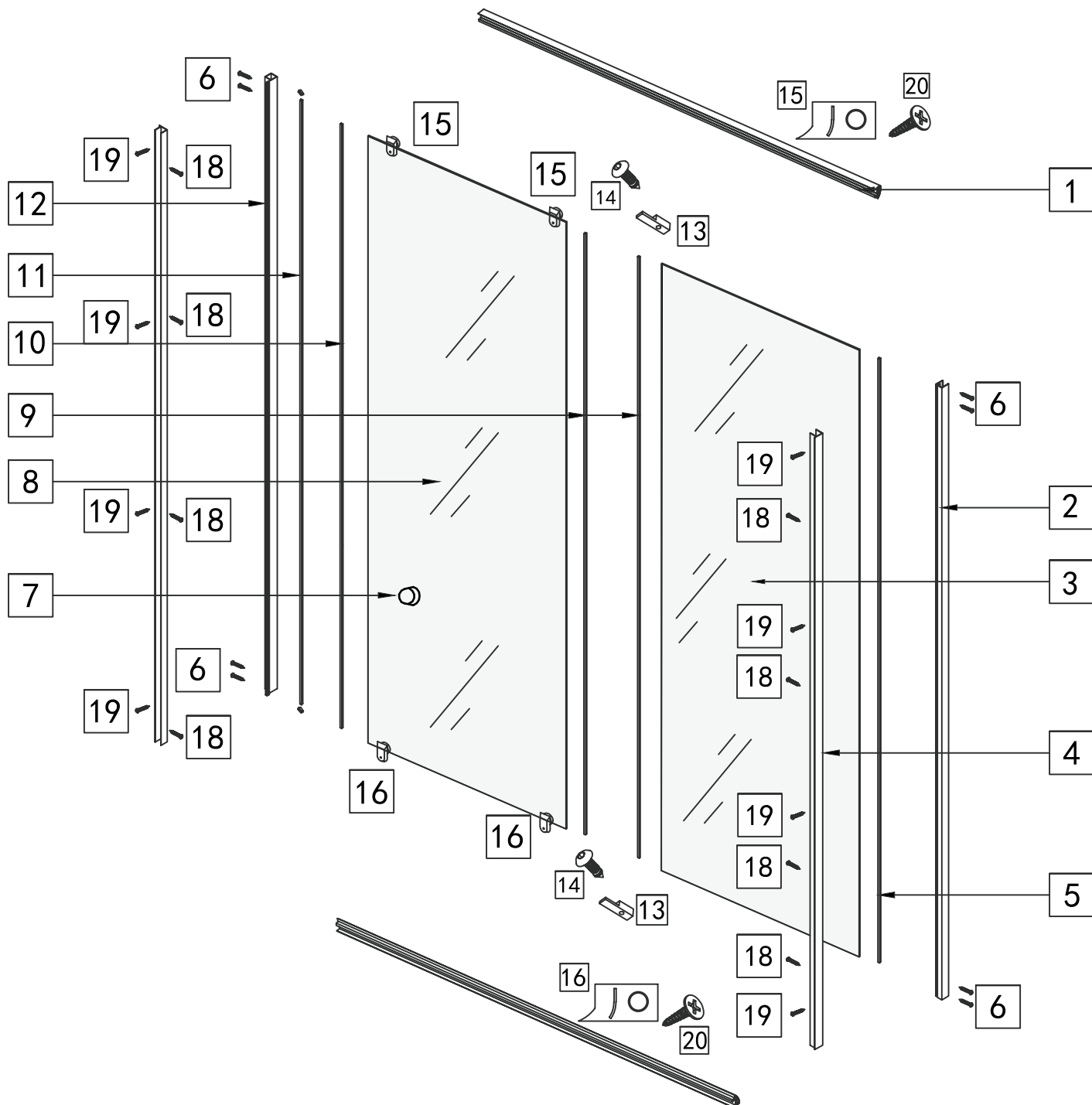

1

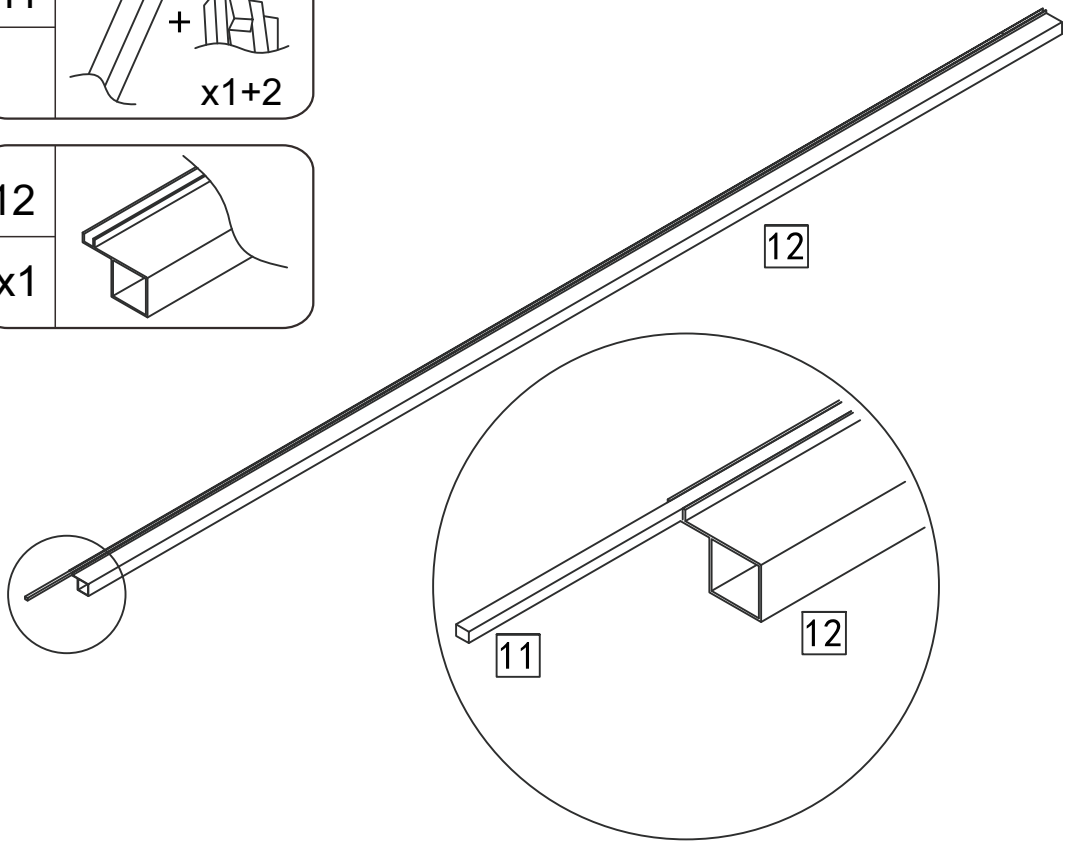
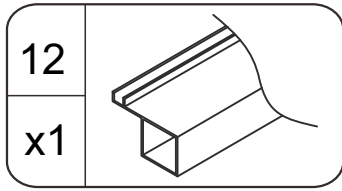
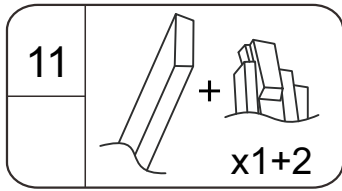

2

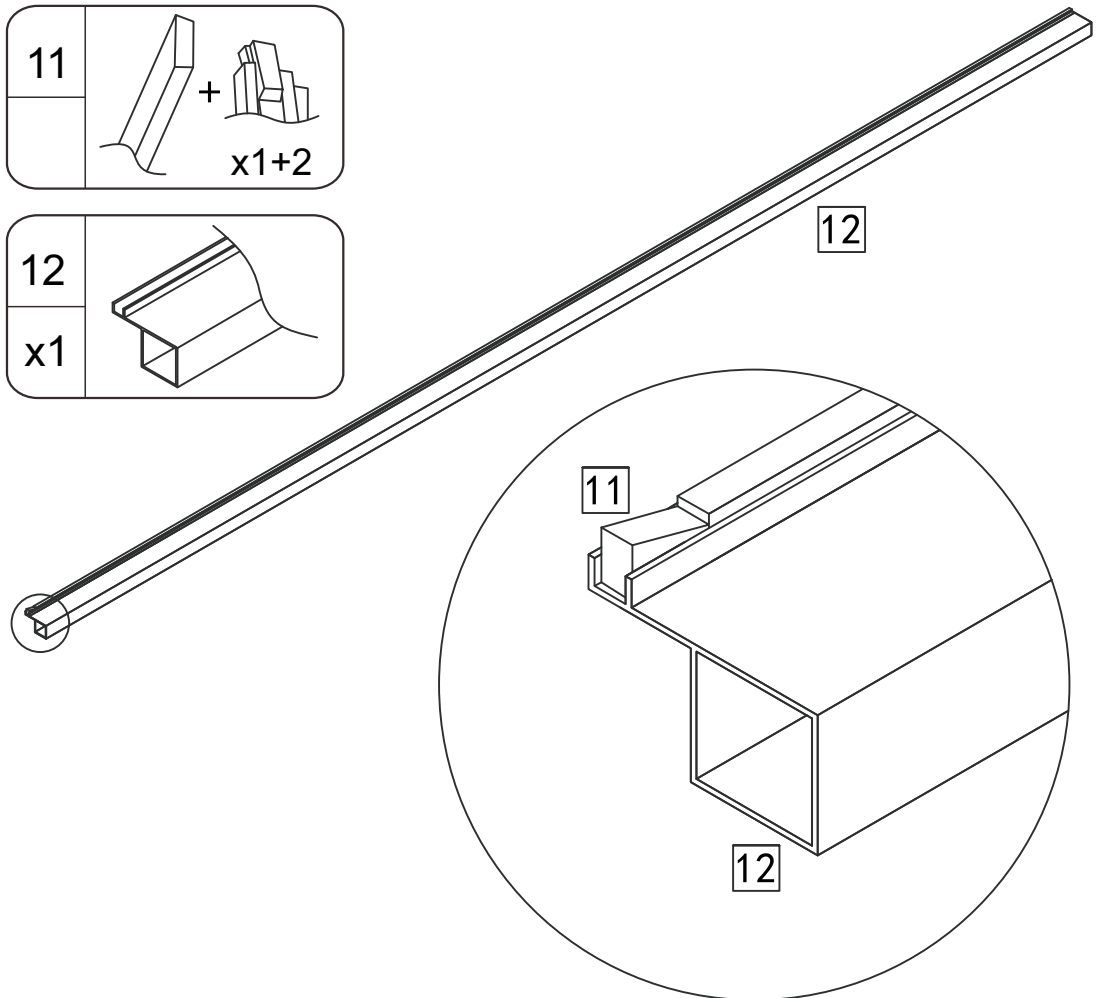
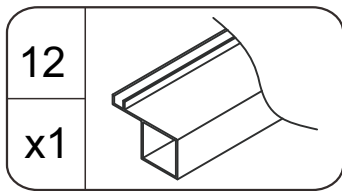
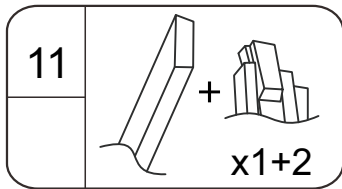

3

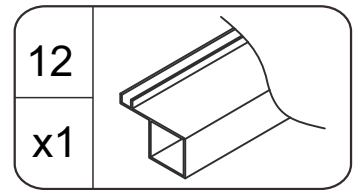
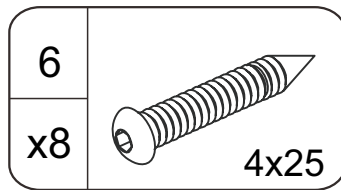
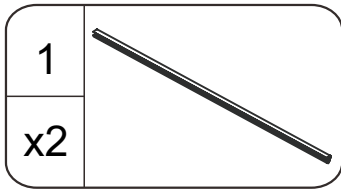
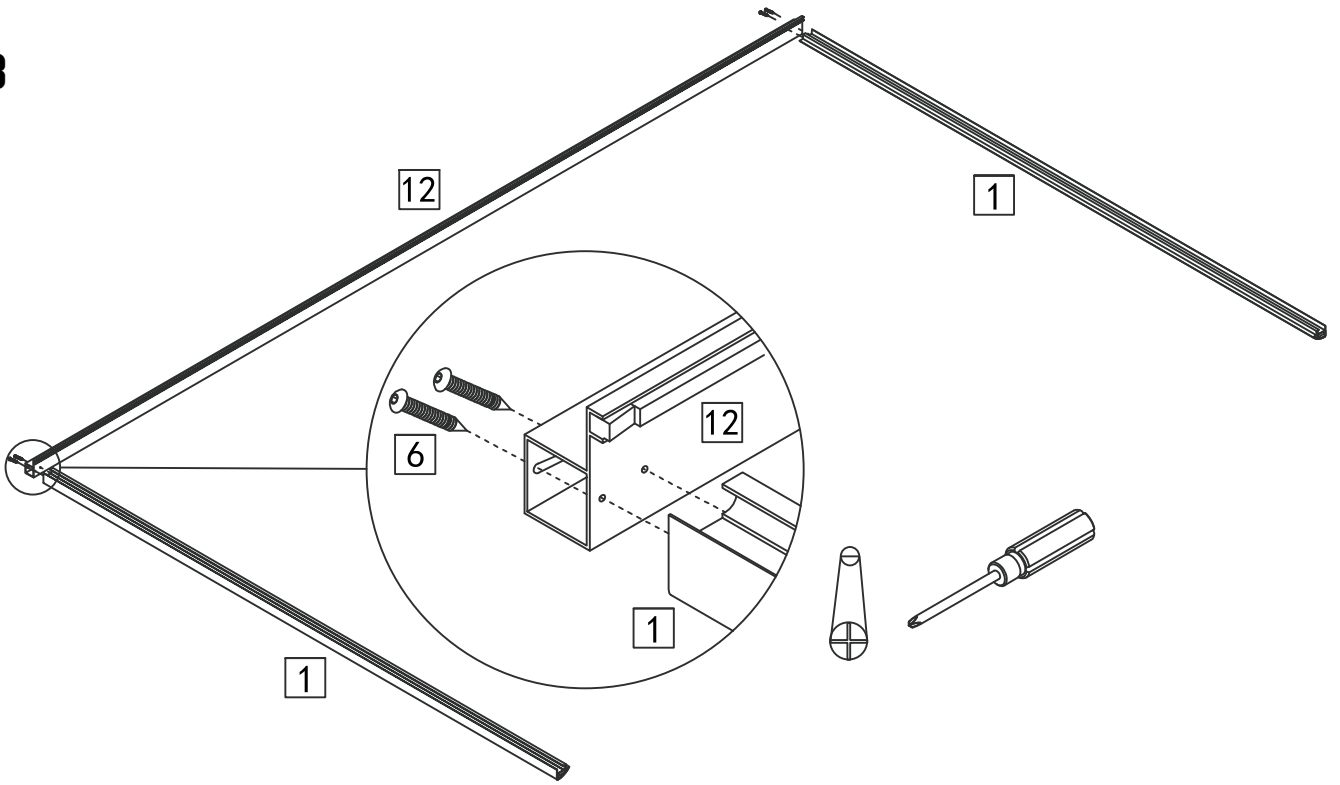

4

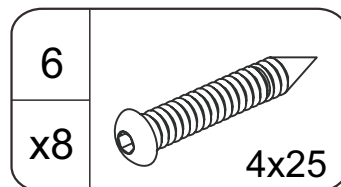
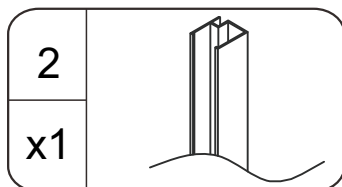
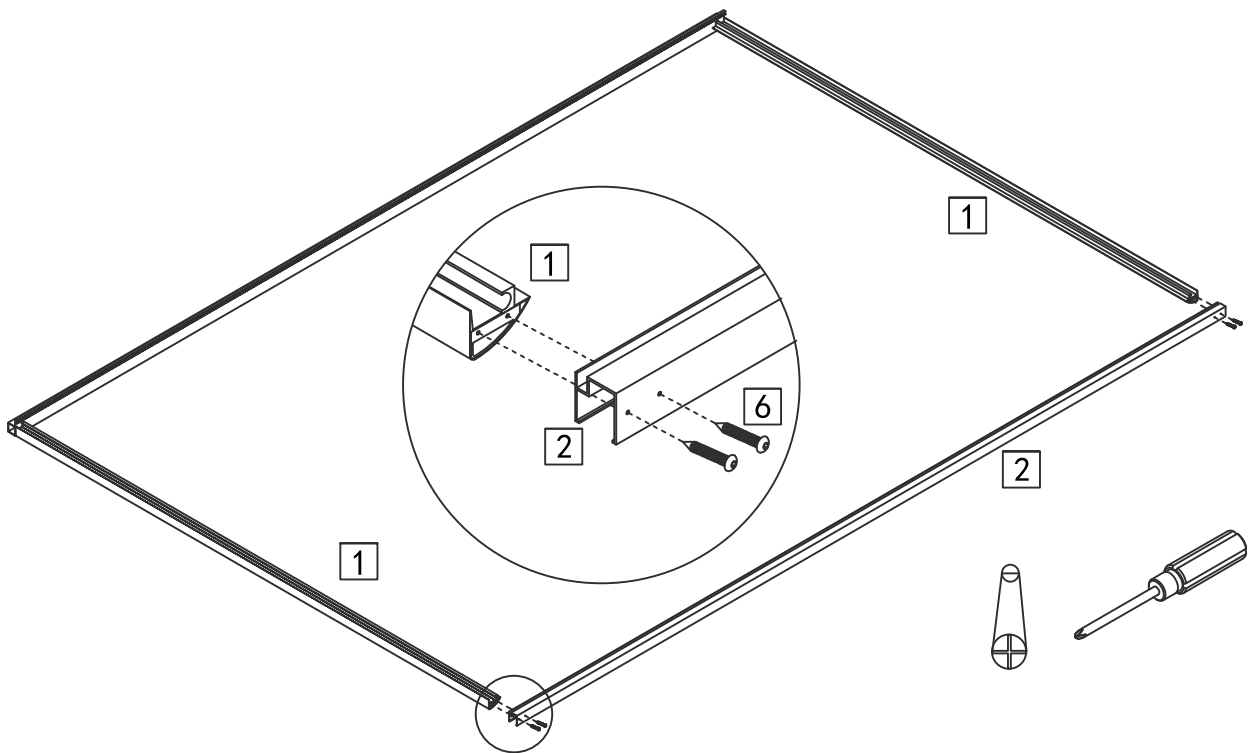

5

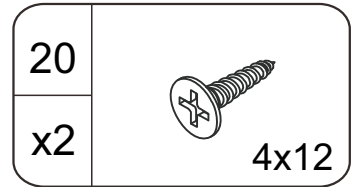
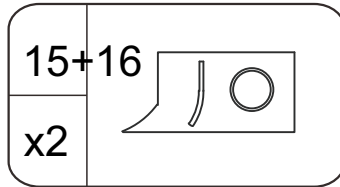
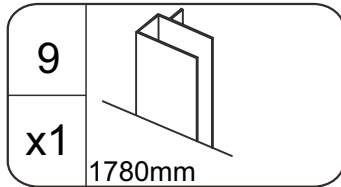
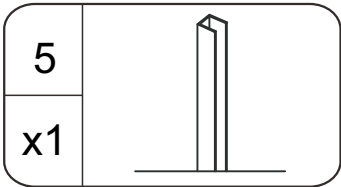
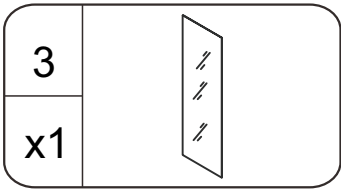
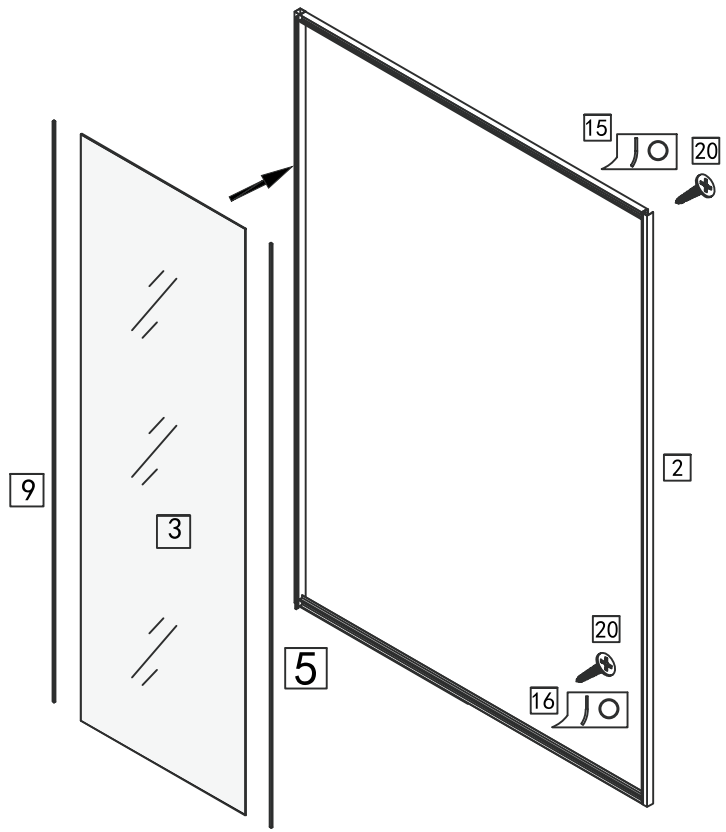

6

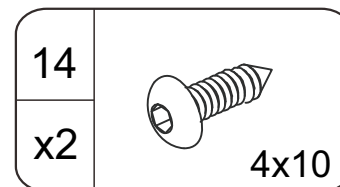
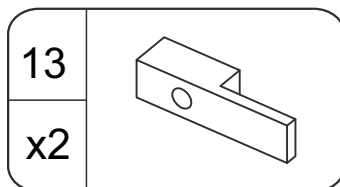
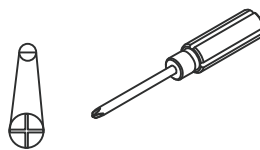
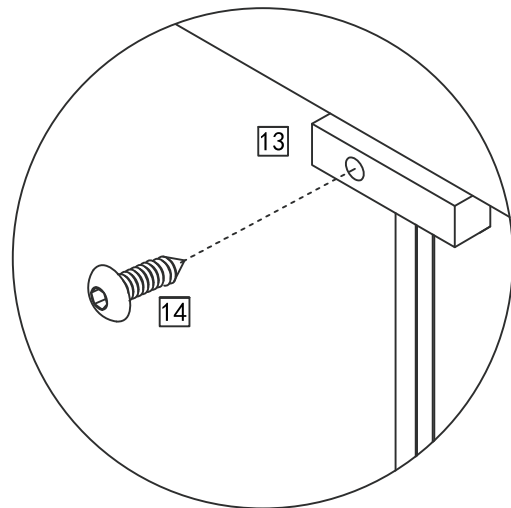
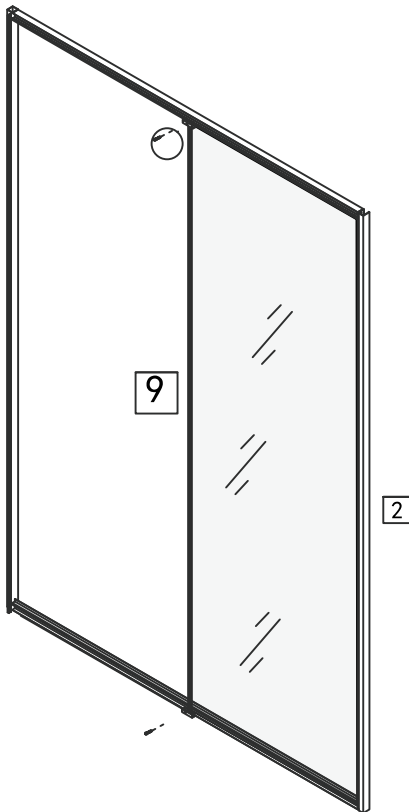

7

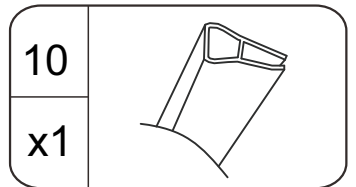
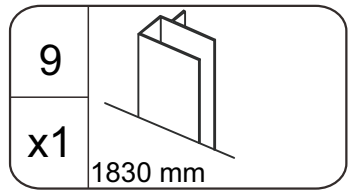
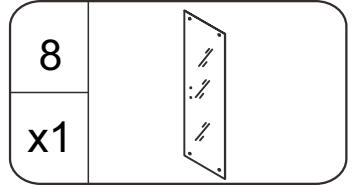
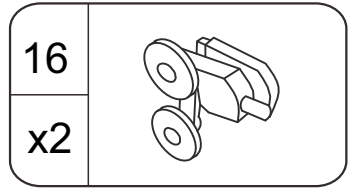
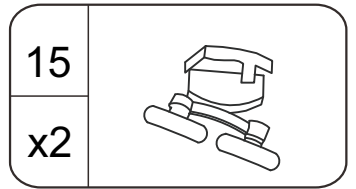
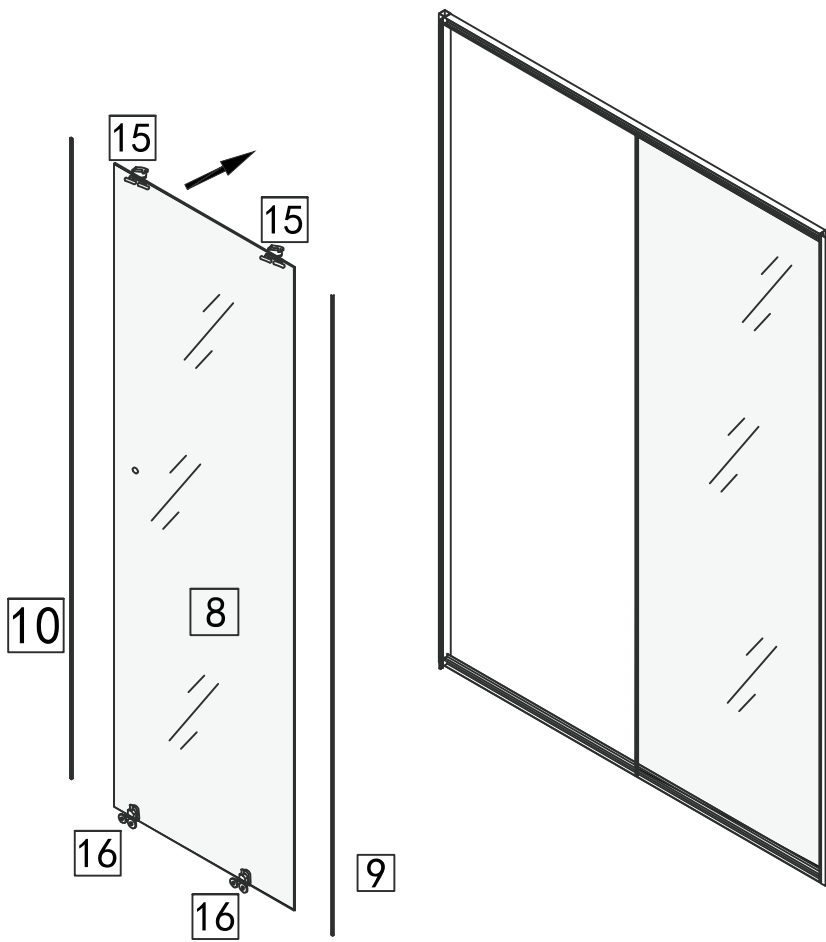

8

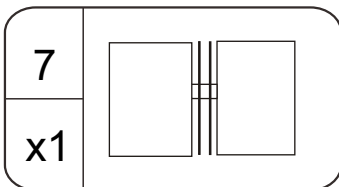
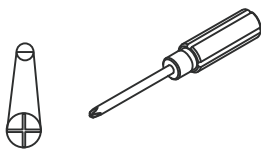
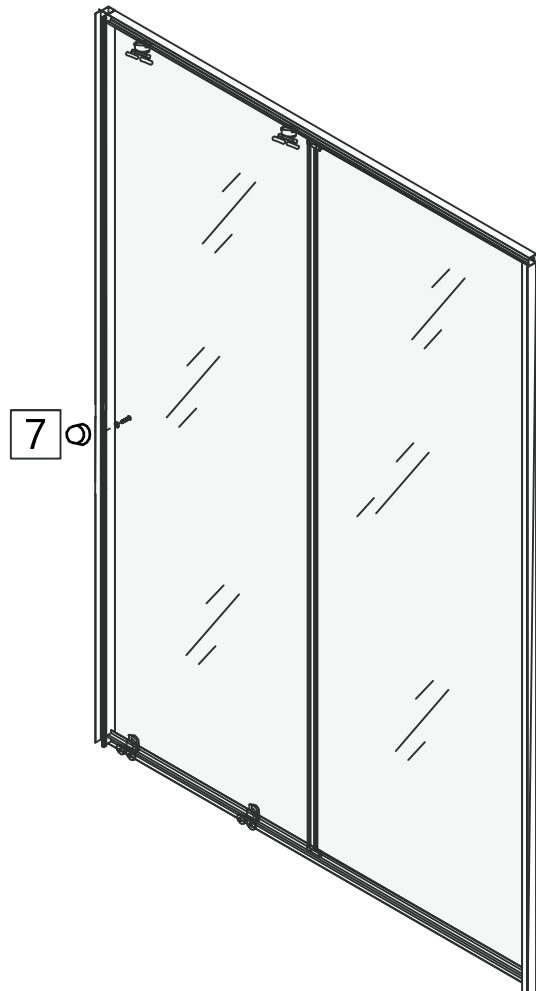

9

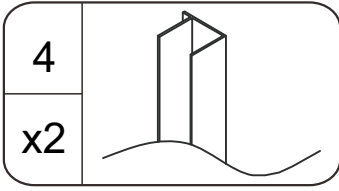
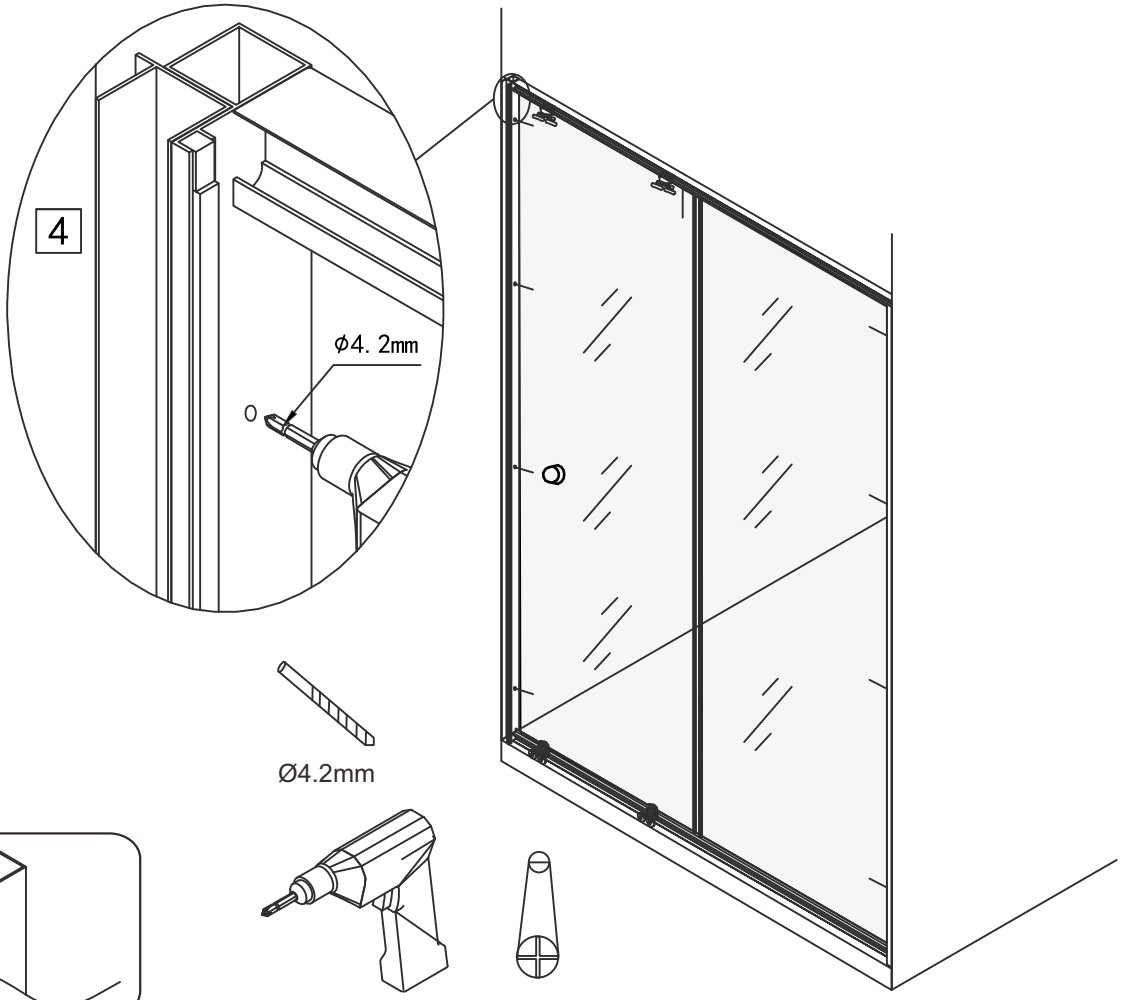

10

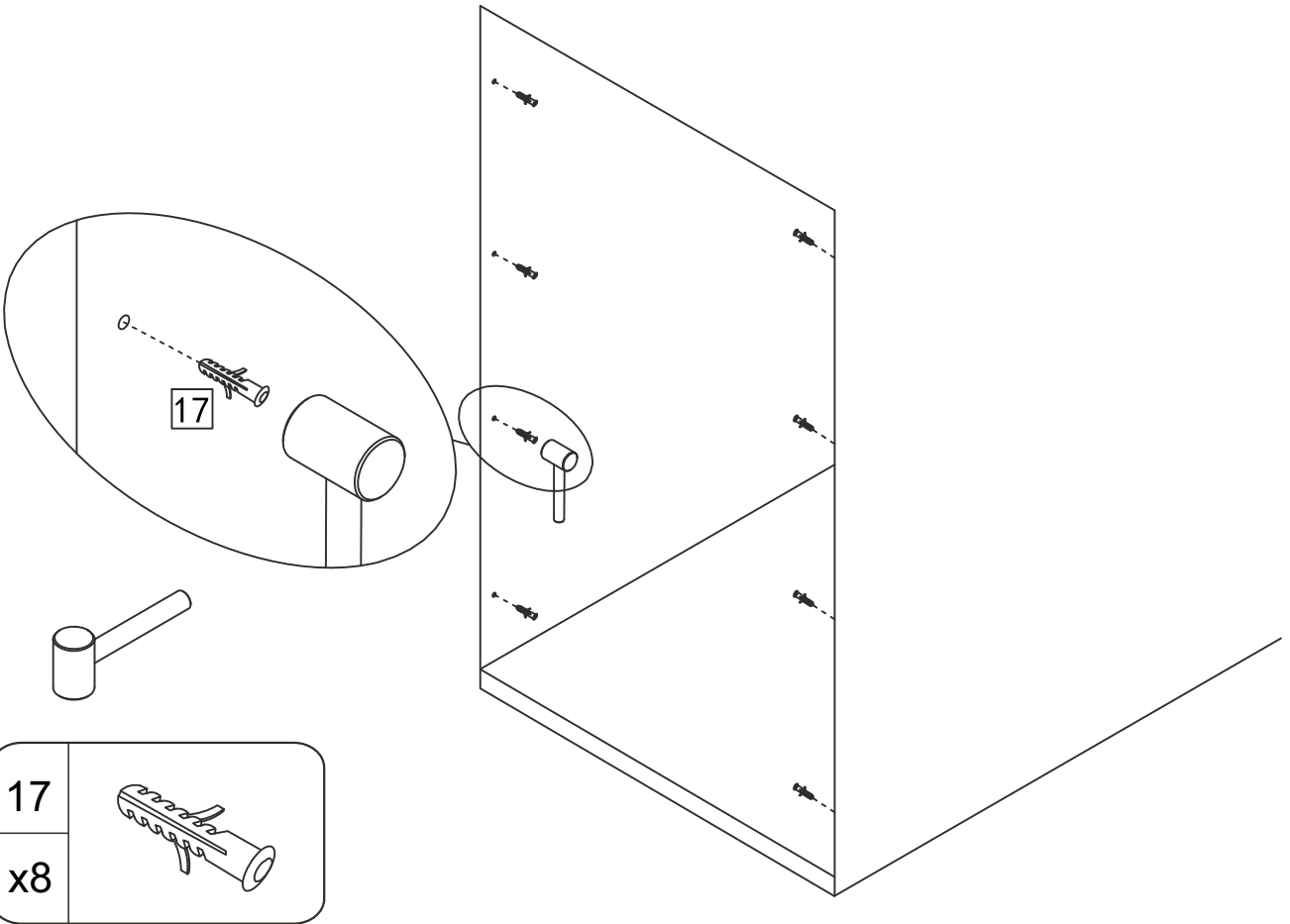



11

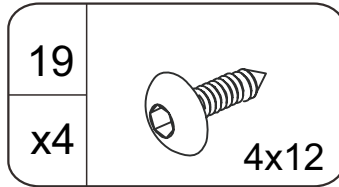
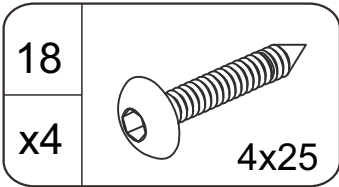
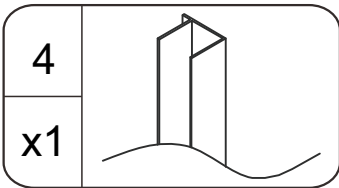
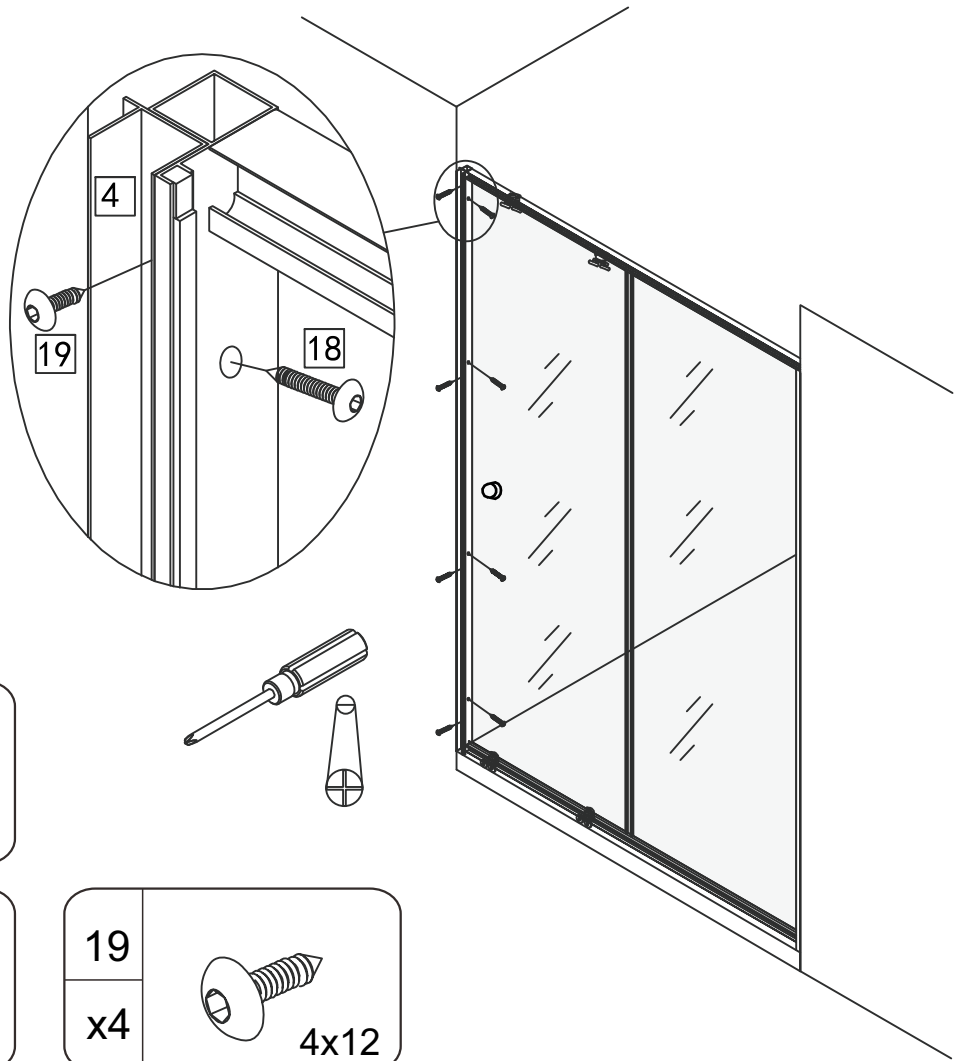

12

